



# INSTALLATION INSTRUCTIONS

## SLIP ON | TOURING™ KNOCKOUT, RIOT, SNIPER, TOP GUN, HITMAN, IMPACT

### MINIMUM REQUIRED TOOLS:



1/2", 9/16", 10mm,  
WRENCHES



1/2", 9/16", 10mm,  
SOCKETS & RATCHET



TORQUE  
WRENCH

### INCLUDED HARDWARE:

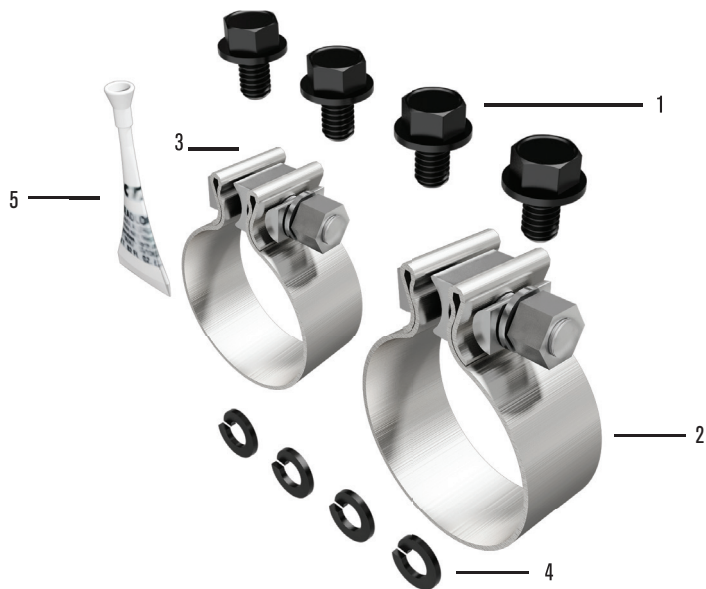

- 1. (4) BOLT HEX FLNG BLK 5/16-18x0.50
- 2. (1) MUFFLER CLAMP 2.50 inch
- 3. (1) MUFFLER CLAMP 1.75 inch
- 4. (4) WASHER SPLIT LOCK 5/16" BLK
- 5. (1) THREADLOCK



SYSTEM SHOWN IN CHROME

- CHROME** PART #7202101 #7201203 #7202301 #7201103 #7202601  
#7201005 #7202201 #7201003 #7202401 #7200805  
#7202501 #7200905
- BLACK** PART #7201002 #7200902 #7201104 #7200802 #7200904  
#7201004

\*PRODUCT MAY VARY FROM IMAGE SHOWN



- 1. RIGHT SLIP-ON
- 2. LEFT SLIP-ON



## IMPORTANT INFORMATION

1. Register your new product at [www.magnaflow.com/motorcycle/register](http://www.magnaflow.com/motorcycle/register).
2. When installing new MagnaFlow exhaust systems, be sure your hands are clean and free of oil, lotion or similar products. After installation is completed and before starting the motorcycle, thoroughly clear the new exhaust system with a clean, soft cloth and cleaning solvent that leaves no residue. Debris, residue or fingerprints left on the system may cause damage to the finish. Damage or discoloration to finish is not covered by warranty.
3. MagnaFlow advises replacing worn or damaged gaskets.
4. Make sure there are no exhaust leaks at the junctions and connecting points of the exhaust pipes and/or mufflers, or at the cylinder.
5. Leaks due to improper installation may cause the engine to overheat. This may cause discoloration.

Maximize your motorcycles performance and efficiency by complementing your new MagnaFlow exhaust system with a fuel tuner management system and or EFI remapping. Remapping is suggested to optimize performance while reducing the possibility of damage to your motor or new exhaust system.

NOTICE: MagnaFlow makes every effort to design exhaust systems which enhance the riding experience. However, due to restraints on some models, tolerances, ground and or cornering clearance may not improve and in some cases may be reduced. Adjustments to the motorcycle not listed here may be required for proper fitment. Be sure to carefully follow all installation instructions.

**DISCLAIMER: NOT LEGAL FOR SALE OR USE IN CALIFORNIA ON ANY POLLUTION CONTROLLED MOTOR VEHICLES.**

Some part numbers not available in California. The California Air Resources Board (CARB) does not permit the use of aftermarket emission-related part(s) that alter the performance of OEM emission-related devices unless CARB has issued an Executive Order. Check Federal, State and local laws for compliance.

Platforms, model names and descriptions including but not limited to Dyna®, Softail®, Sportster®, Touring®, Fat Boy®, Road Glide®, Heritage® and Harley® are registered trademarks of The Harley-Davidson Motor Company®, Milwaukee, WI, U.S.A.

### CALIFORNIA EMISSIONS NOTICE

Some part numbers are not legal for sale or use in California. The California Air Resources Board (CARB) does not permit the use of aftermarket emission-related part(s) that alter the performance of OEM emission-related devices unless CARB has issued an Executive Order, other than on racing vehicles on closed courses. Check your local laws and manufacturer's information.

In California, the sale and installation of motorcycle aftermarket exhaust parts that may have the potential to impact emissions are regulated by the California Air Resources Board (CARB). The sale, installation and use of emissions related aftermarket exhaust parts on motorcycles is prohibited unless the exhaust part is either an OEM "replacement part" as defined by the state of California, or is specifically permitted for use by an Executive Order issued by CARB.

#### (1) Replacement Parts

Replacement Parts are aftermarket parts that are functionally identical to the stock OEM part they are intended to replace, and therefore do not adversely impact emissions when installed and in use. Replacement Parts are permitted for sale, installation and use on motorcycles used on or off the public highways in California. For motorcycles, these parts fall in to two categories:

### CALIFORNIA EMISSIONS NOTICE (CONT.)

\* No emission control - If the motorcycle's stock exhaust system does not contain any emission control components, then an aftermarket exhaust part is a Replacement Part and no EO is required.

\* Upstream emission control devise. If the motorcycle's stock exhaust system contains a catalytic converter, then an aftermarket exhaust part positioned downstream from the catalytic converter (i.e. cat-back) is a Replacement Part as long as it does not remove, replace or adversely affect any emission control equipment originally attached to the stock exhaust system.

#### (2) Executive Order Parts

All exhaust parts that incorporate or impact any emission control devise require a CARB issued Executive Order allowing the parts to be advertised, sold, offered for sale and installed in California, pursuant to specific application.

For more information please visit <http://www.arb.ca.gov/msprog/aftermkt/motorcycle1/motorcycle1.htm>

### WARRANTY:

MagnaFlow motorcycle exhaust products, including Arlen Ness by MagnaFlow exhaust systems, are warranted against defects in material and/or assembly workmanship only for a period of 1 year from invoice date. This warranty is void if the product is not installed properly on the vehicle for which it is designed. This warranty does not apply to any product which has been installed on any commercial or racing vehicle or which has been improperly installed, modified, altered or subjected to misuse or damage from accidents; including excessive heat. Also, cost of labor and any additional parts or components required to complete installation of a replacement product are not covered by this warranty; including coatings, paints and/or finishes, flaws or rust. MagnaFlow including Arlen Ness by MagnaFlow exhaust systems are designed to fit and operate on original OEM motors and chassis with no modifications of any type on the motorcycle.

Proof of purchase from an authorized retailer must accompany any warranty claim. The original product that is deemed to be under warranty may only be returned and/or exchanged for a product of the same part number. No other warranty, expressed or implied (including merchantability), applies to the products, nor is any person including the manufacturer authorized to assume any other warranty. Dealers and distributors are not authorized to make warranty judgments or claims regarding MagnaFlow products. The manufacturer does not assume any responsibility for any consequential damages occasioned by the product, or inconvenience or interruption in any operation, service or shipping. All approved warranty returns must be accompanied by a return authorization number. Parts returned to MagnaFlow without a return authorization and accompanying documentation may be refused. No parts will be accepted with freight due.

This warranty gives you specific legal rights. You may also have other rights which may vary from state to state. Some states do not allow the exclusion or limitation of incidental or consequential damages, so the above limitation or exclusion may not apply to you.

The warranties set forth herein are exclusive and, unless otherwise required by applicable law, no other warranties are made by MagnaFlow or are authorized to be made with respect to the product.



1. Locate and remove the two D-ring pins inside of each stock saddlebag. (Figure 1)



Fig.1a



Fig.1b

2. Remove each saddlebag by carefully lifting them up and away from the motorcycle. Safely set saddlebags to the side. (Figure 2)



Fig.2

3. Locate and loosen the factory clamp at the inlet side of the OEM mufflers. (Figure 3)



Fig.3

4. Remove the two 5/16 inch bolts and washers attaching each muffler to the saddle bags mounts. (Figure 4)



Fig.4

5. Slide each muffler towards the rear of the bike to remove it from the head pipe assembly.

*Note: Penetrating lubrication may be necessary to assist in the removal of the muffler. (Figure 5)*

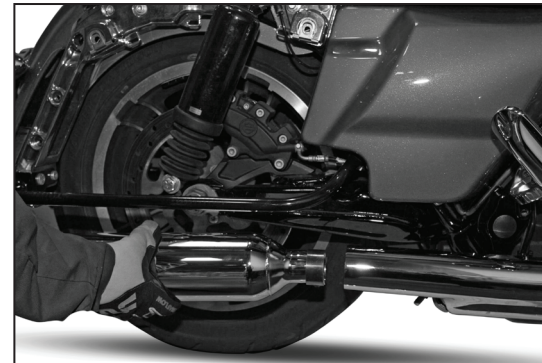

Fig.5



1. Install the supplied clamps on the inlet side of each muffler with the bolt head up. (Figure 6)

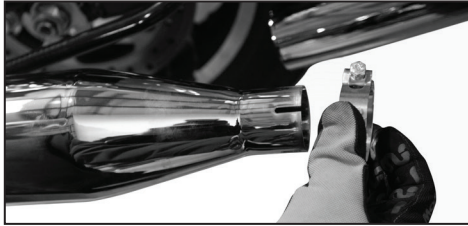

Fig.6

2. With the logo plate facing outward, slide each of the MagnaFlow mufflers on to the head pipe assembly. Do not tighten the muffler clamp at this time to allow for adjustment. (Figure 7)

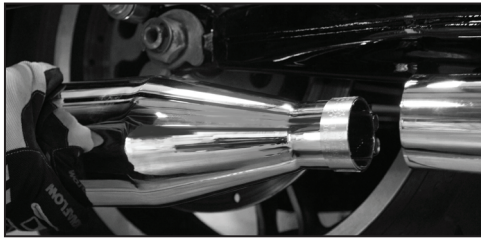

Fig.7

3. Apply the threadlocker to the four supplied 5/16 inch bolts. (Figure 8)



Fig.8

4. Install the bolts and supplied washers through the saddle bag mounting plate and to the top of each muffler. Do not tighten the bolts at this time to allow for adjustment. (Figure 9)

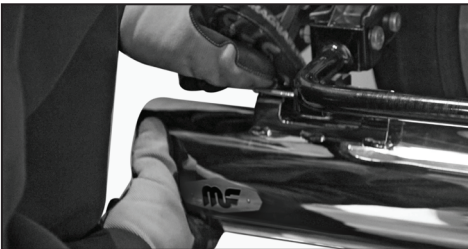

Fig.9

5. Align the mufflers correctly, then tighten the 5/16 bolts to the recommended 13-19 Ft/Lbs. (Figure 10)



Fig.10

6. Tighten the muffler clamps to the recommended 45-50 Ft/Lbs. (Figure 11)

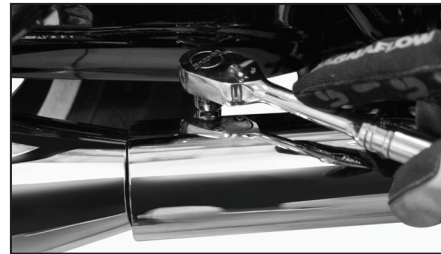

Fig.11

7. Clean the mufflers to remove any oil or residue. Please reference item 2 on Important Information page. (Figure 12)

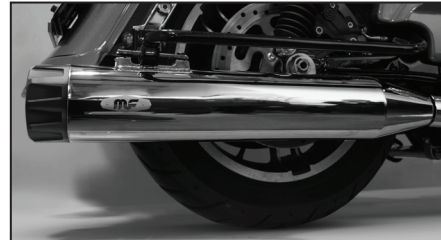

Fig.12

8. Start the engine and check for any exhaust leaks. Re-adjust or tighten as necessary. Please reference item 2 on the Important Information page.